

hyperCAD[®]

© The helmet was programmed and produced by DAISHIN



CAD for CAM

CAD-INTEGRATION

 **OPEN MIND**
THE CAM FORCE

In a class of its own among CAD systems

Only a high-end CAM developer can do CAD for CAM. With this in mind, Open Mind Technologies AG – known as an innovative pioneer – developed a new CAD system from scratch that is perfectly matched to *hyperMILL*[®]. The system has its own 3D CAD kernel from OPEN MIND. The result is a unique CAD system for CAM programmers that is very easy to learn and that vastly accelerates NC programming processes.

hyperCAD^{®-S} fully exploits the performance offered by contemporary hardware systems to create digital manufacturing data. The advanced and extremely powerful 64-bit system is the perfect solution for mastering many of the daily challenges that arise when working with meshes, faces and solids to create precise components and tools. Large volumes of imported data can be prepared for subsequent NC programming easily, quickly and safely and completely independently from the original CAD system. *hyperCAD*^{®-S} is pure ‘CAD for CAM’.



Interfaces

Geometric
Engine

Solids

Mesh

Deformation

“At last we’ve got a CAD system for CAM programmers!”

Stefan Nagel, Deputy Managing Director of Kiefer Werkzeug- und Vorrichtungsbau, Pfullingen

Features

- CAD for CAM
- 64-bit multi-application
- Top performance
- Optimal ergonomics
- Highly intuitive
- Optimal hardware utilisation

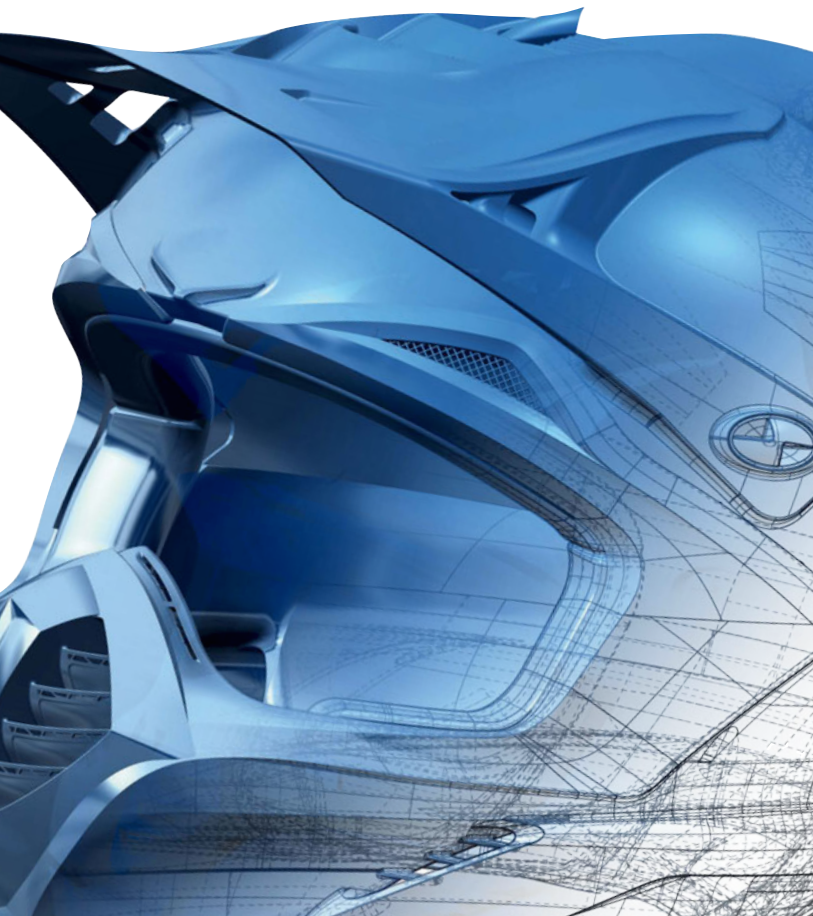

CAD for CAM

CAM programmers use CAD systems differently from most engineers and designers. *hyperCAD*®-S is therefore designed entirely to meet the demands of CAM users. Efficient CAM programming is of primary importance and perfectly supported by the CAD system.

- **Customisable filter functions:** In addition to familiar properties such as layer and colour, the most common geometric and system properties are available as user-defined filters.

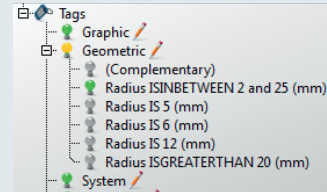

Keyword navigation: Graphic entities can be linked using tags, similar to keywords. This makes it easy to filter all the information about the CAD model. For example: ‘All faces with a radius between 2 and 20 mm’.

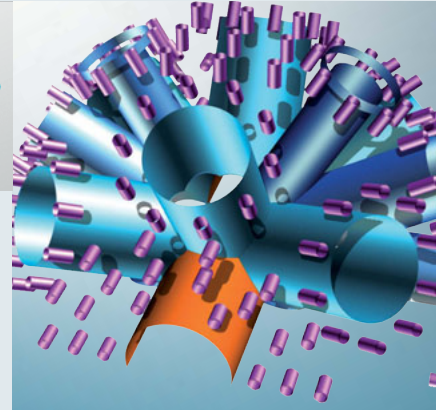

- **Intelligent entity management:** Toolpaths, polygon meshes, point clouds, rectangles – the inclusion of CAM-relevant entities in the CAD kernel speeds up processes greatly.
- **Multi-application mode:** An integrated 64-bit system and IDE-style interface enable opening any number of documents each in its own application. Multiple models can be processed and calculated at the same time.
- **Smooth data exchange:** comprehensive interface package. **Import:** Standard: IGES, STEP, STL, DXF/DWG, Parasolid®, point cloud, *hyperCAD*®. **Direkt:** CATIA V4® and V5®, Autodesk® Inventor®, Siemens NX®, SOLIDWORKS, PTC® Creo. **Export:** IGES, STEP, STL, DXF/DWG, point cloud and *hyperCAD*®.
- **Intuitive operation:** Self-explanatory icons and a highly transparent user interface without any hidden functions secure and accelerate operating procedures.
- **All languages:** Available in all the same language versions as *hyperMILL*®.

Geometric Engine – the right CAD basis from the start

Every CAM programmer is familiar with the standard CAD tasks of selecting, adding, deleting, modifying, showing and hiding faces, curves and points. Users expect top-quality results from the ruled, filling and offset faces that they create. *hyperCAD*[®]-S offers all this and much more. OPEN MIND took great care when developing the CAD innovation to adapt the range of CAD functions to meet the real needs of CAM programmers rather than designers.

Instead of relying on numerous distributed submenus (as is the case in conventional design systems), *hyperCAD*[®]-S uses central, user-friendly dialogues with large icons. Smart selection mechanisms and innovative, freely definable filter functions make it considerably easier to use geometric entities for subsequent programming. Imported geometry can be cleaned quickly if needed using standard surface modifying tools.

Close holes From limits
Rotational face Along a guiding line
Plane **FACES** Fill face
Ruled face Limited plane
From cutting curves Trim
Offset Linear extrusion
Invert orientation
Shape contour Project
Penetration Splines
Isoparametric **CURVES** Split
Machine interpolation control points Join
Lengthen/shorten From limits
2D/3D spiral Adjust
Join Trim automatically
Centres curves

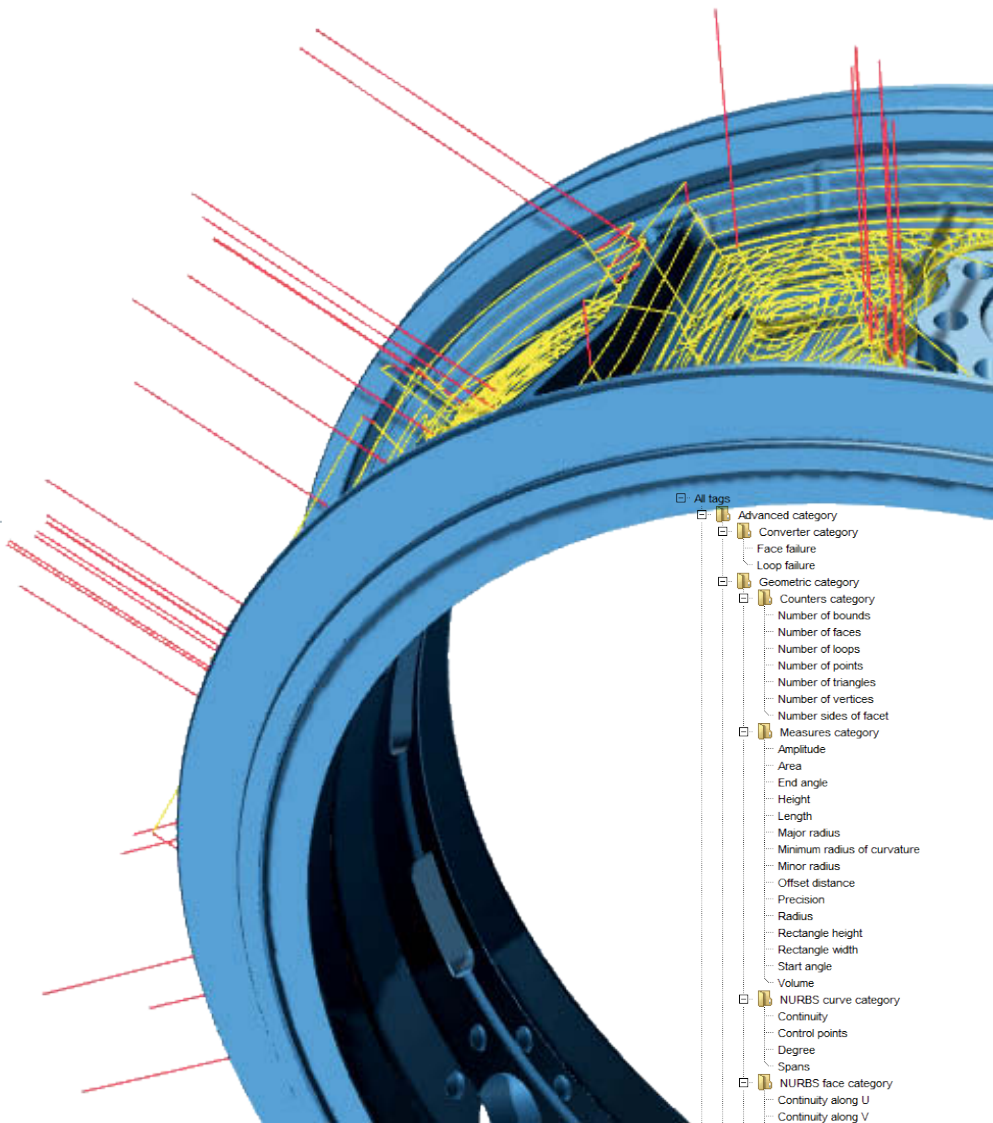

- **Fully compatible with hyperCAD®:** It goes without saying that *hyperCAD®-S* is compatible with *hyperCAD®*. All versions are fully supported: E3, E2 and GKD files, job lists and entity selection.

- **A new way to navigate:** Powerful navigation and selection functions provide support for working with large models.

- **Fast repairs and modifications:** As every CAM programmer knows, most imported external data records contain errors. *hyperCAD®-S* therefore contains a number of repair functions designed to speed up subsequent CAM processes. Geometry areas can also be easily edited at any time.

- **Comparing geometries:** A fast geometry comparison immediately shows where exactly new versions of customer components have changed.

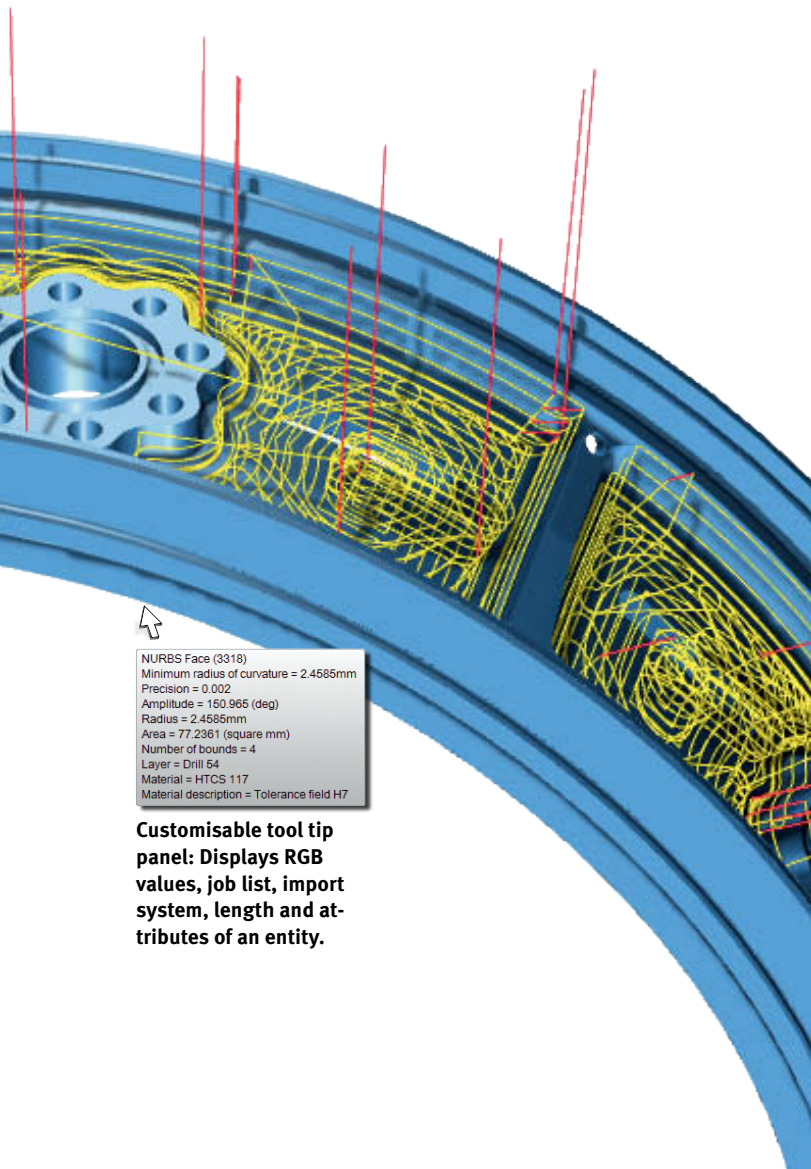

NURBS Face (3318)
 Minimum radius of curvature = 2.4585mm
 Precision = 0.002
 Amplitude = 150.985 (deg)
 Radius = 2.4585mm
 Area = 77.2361 (square mm)
 Number of bounds = 4
 Layer = Drill 54
 Material = HTCS 117
 Material description = Tolerance field H7

Customisable tool tip panel: Displays RGB values, job list, import system, length and attributes of an entity.

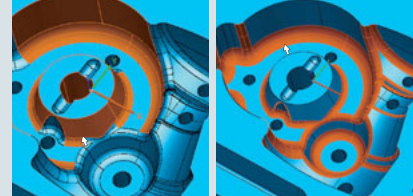

Coaxial

Fillets

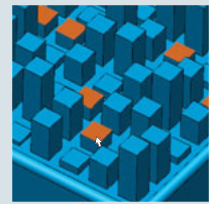

Coplanar

Tangential

Smart selector technology for faces and skins: various selection options for curves: 'from...to' chain selection and for faces: tangential, limited, coaxial, coplanar, fillets and chamfers.

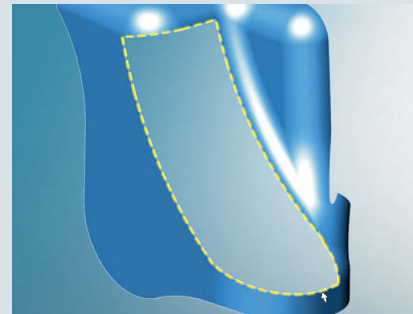

Planar and non-planar filling faces: Faces that are to be filled can be automatically closed – at face edges as well.

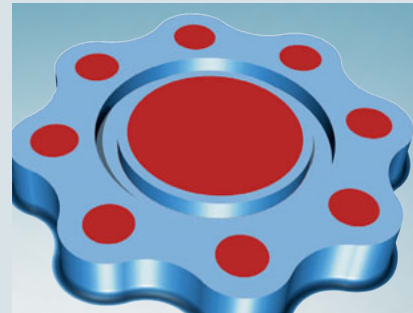

Multiple work planes: It is possible to define multiple work planes. Saved work planes make it easy to perform transformations. They can also be imported to other files at any time.

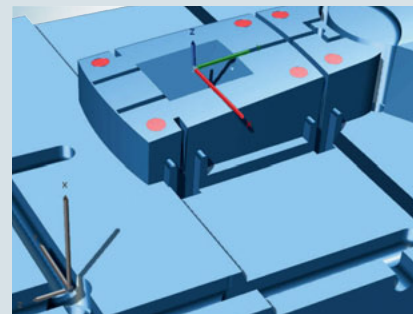

Standard preparation for milling: It is easy to create frequently required building, extension, machining and stop faces in a structured manner. This is also the case with boundary and guide curves as well as construction aids, planes and axis systems.

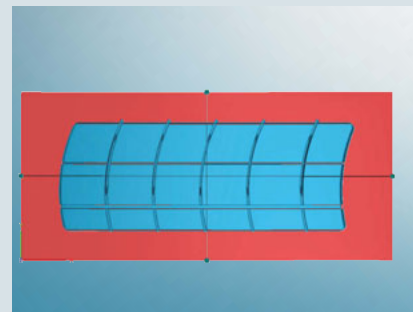

Practical analysis functions: The analysis functions allow draft areas and highly complex geometries to be located quickly and reliably. This enables assessing the quality of an existing component immediately. Problems are recognised quickly.

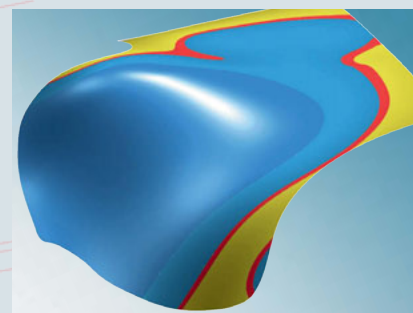

Solids – efficient solid modelling

hyperCAD[®]-S Solids – the module for solid modelling – was, of course, also developed primarily for CAM programmers. In contrast to engineers and designers, this group requires features without a history tree during solid modelling. Why make it complicated if doing it directly is quicker? With the innovative approach to direct modelling offered by *hyperCAD*[®]-S Solids, solid modelling becomes a real joy: After the faces or features of a solid model have been selected, the position and shape of the faces of the solid model can be modified in real time simply by dragging handles and manipulators. And the best thing is that direct modelling does not only work with native data but also with external data that have been imported and have no feature history information.

The *hyperCAD*[®]-S Solids module allows all solid models to be reliably imported, created, converted, modified and combined. Working with solid models becomes noticeably easier and much more intuitive: Chamfers, fillets and holes can be directly moved, reduced, enlarged or deleted by means of recognised features. The use of existing features and associated functionalities allows CAM programmers who work with faces and solids to be more productive and flexible.

Features

- Direct modelling
- Numerous features
- More convenient
- Adds flexibility

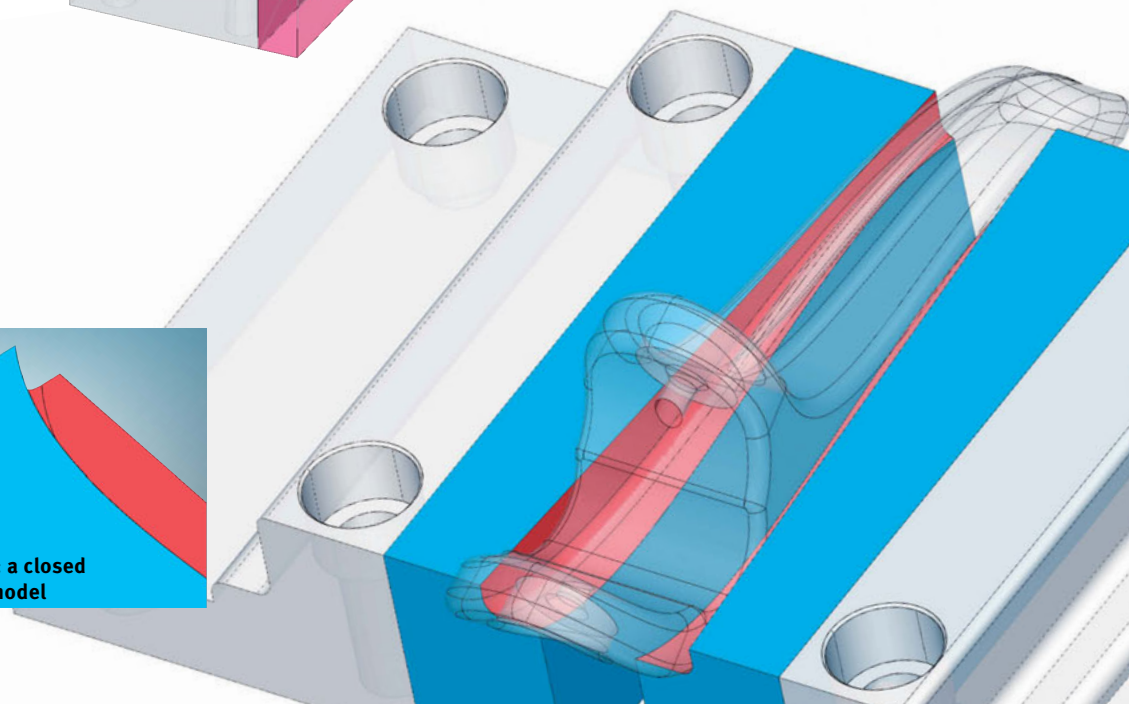
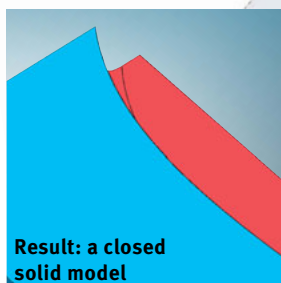
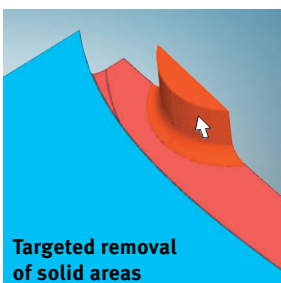
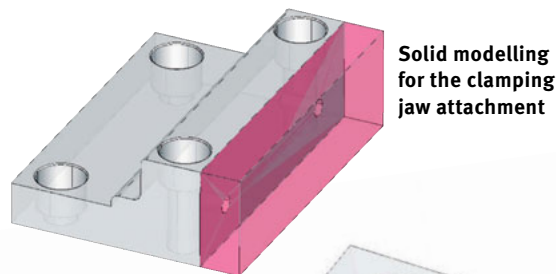

Standard features

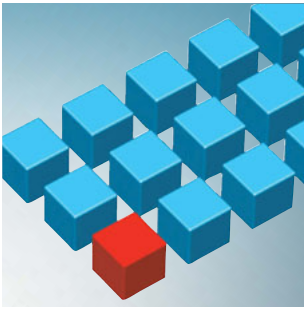

Pattern

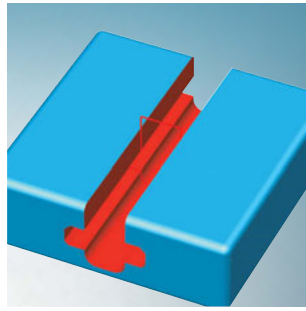

Linear slot

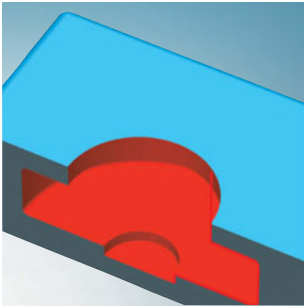

Rotational slot

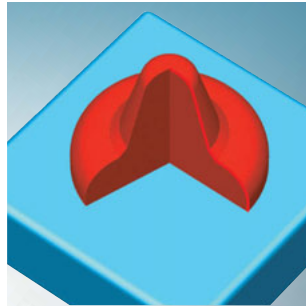

Rotational protrusion

- **Reliable import of external data:** When external data are imported, they are handled in the same way as native CAD data. All construction data, such as sketches, faces, single parts or complete machining groups, are transferred and can be modified, if required.

- **Numerous standard features:** Basic structures, linear extrusions, rotational solids, linear and rotation slots, pockets, simple and complex holes, patterns, chamfers and fillets can be created.

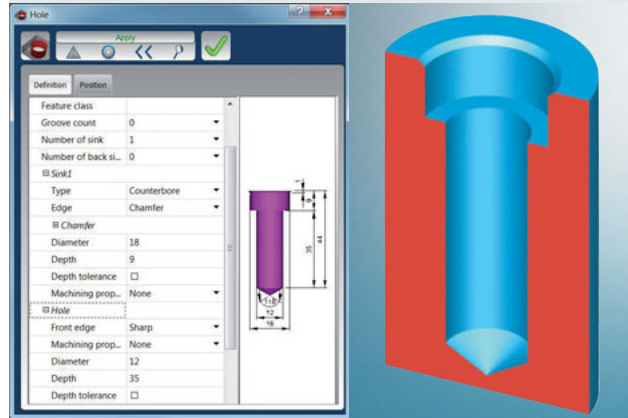

- **Time-saving zone feature:** The zone feature also allows creating user-specific features. Zones can be transformed, copied, deleted or also selected with *hyperMILL*®.

- **Creating solid models from faces:** All it takes is a few clicks to create solid models quickly from closed face formations – and vice versa.

- **Working conveniently with features:** Features that have been created have no history and are not arranged in any particular way. They are stored in the model tree for easy selection. The faces of features can be moved using drag-and-drop operations, in order, for example, to reposition holes. After direct modelling, the shape is recalculated automatically by the system. A wide range of functions are available for machining the features: Delete, mirror, arrange as pattern, offset, move, scale and break.

- **Reliable feature recognition:** Double-clicking an imported face starts the feature recognition. Fillets and chamfers that are recognised are created automatically as features whose dimensions can then be modified again with a smart click.

- **All Boolean operations:** Union, Difference, Intersection and Split.

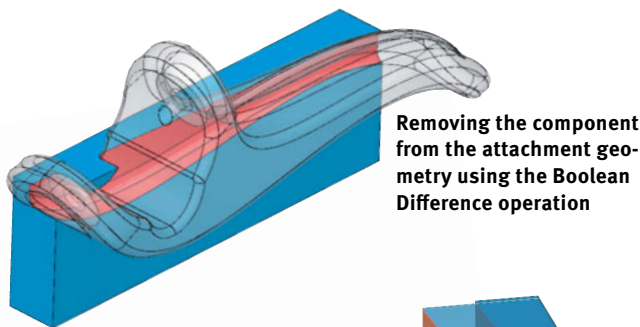

Removing the component from the attachment geometry using the Boolean Difference operation

Direct modelling to widen the attachment

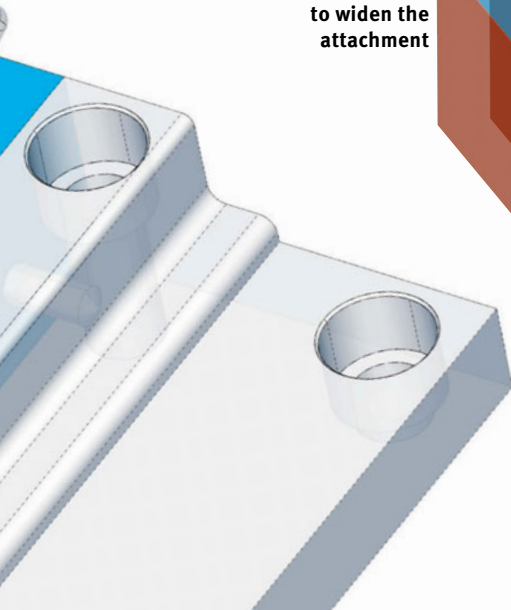
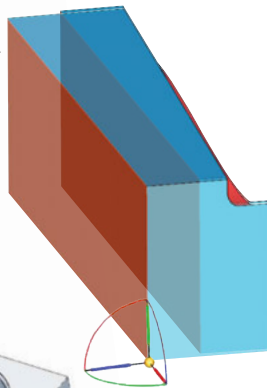

Mesh – Preparing meshes quickly for milling

Scanned, forged and cast parts, clay models and moulds: 3D surface scanners have a wide range of uses. 3D scanners offer precise, high-resolution, full views of 3D objects, mostly combined with a large quantity of data.

The main task of the CAM programmer is to generate a perfect basis for milling a mesh very quickly from a set of scanned data. In order to achieve the best possible milling results, the CAM programmer can use *hyperCAD®-S Mesh* to repair any possible mesh deviations very quickly, perform metrological analyses and checks and prepare meshes conveniently for milling. Six new functions are available for machining meshes.

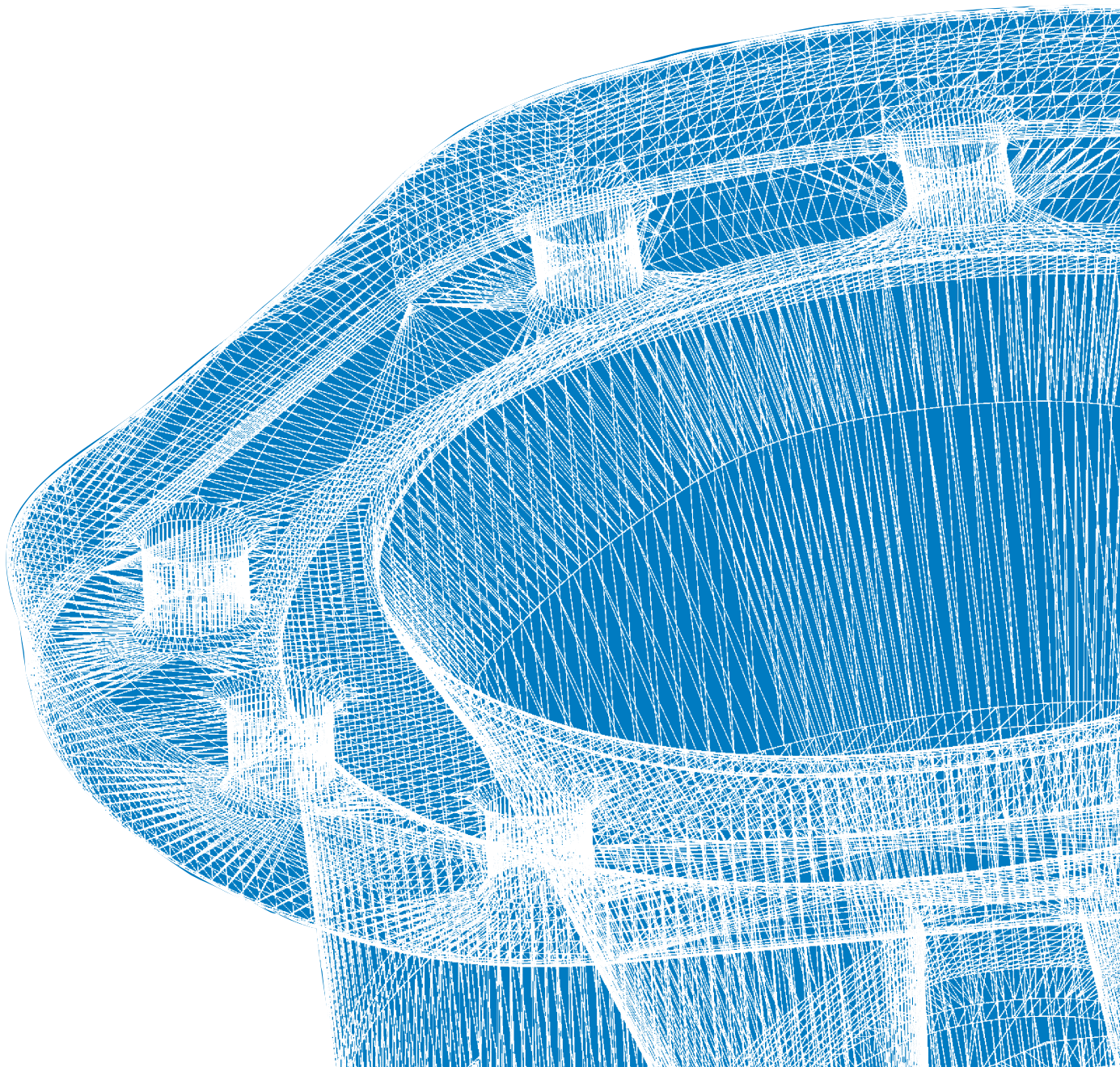

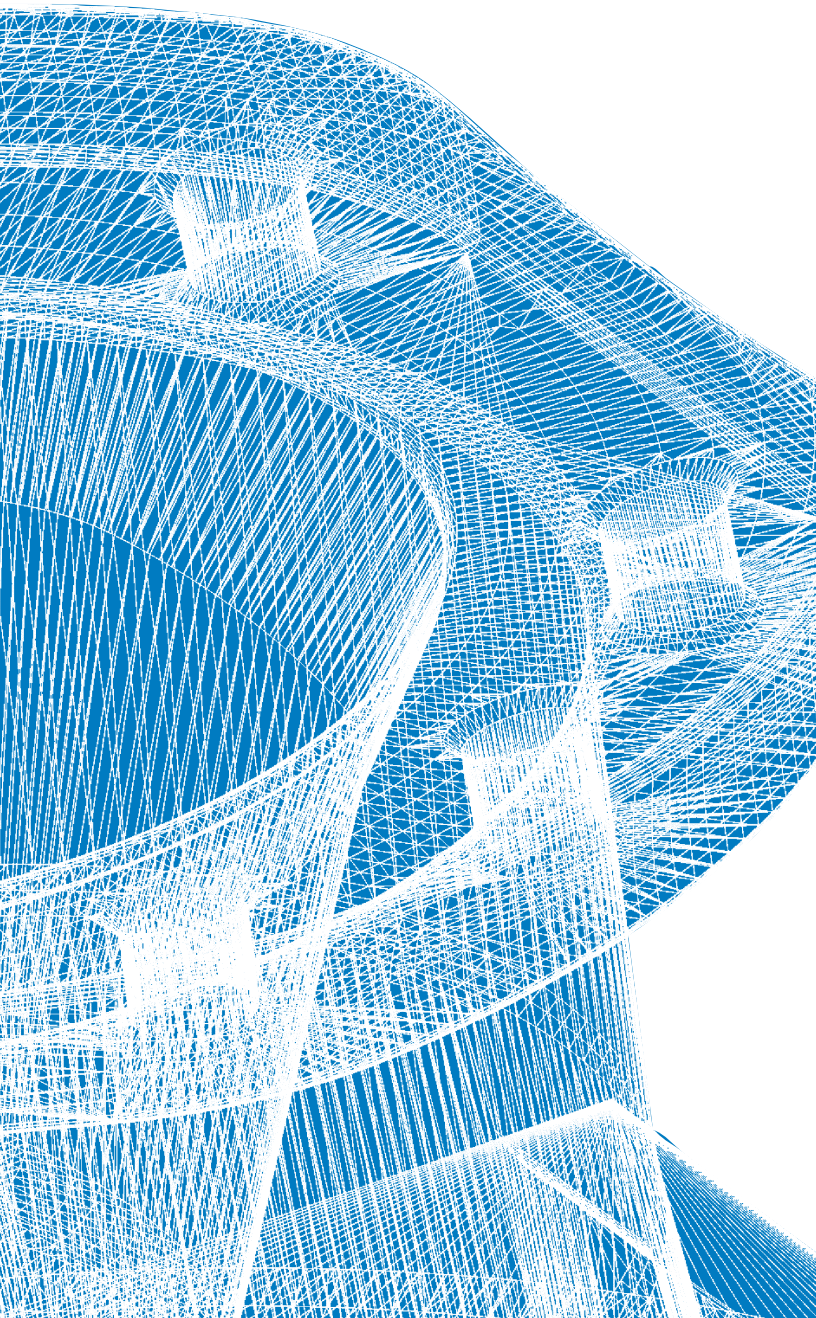

Mesh functionalities

■ Smooth meshes

This function allows the user to smooth meshes in order to repair deviations.

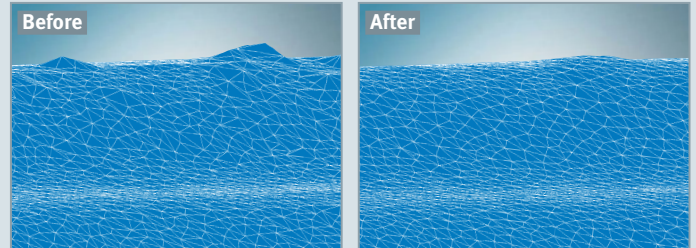

■ Decimate meshes

This function allows the user to reduce the mesh density while retaining the geometry properties. The reduced data volume helps to accelerate the model calculation.

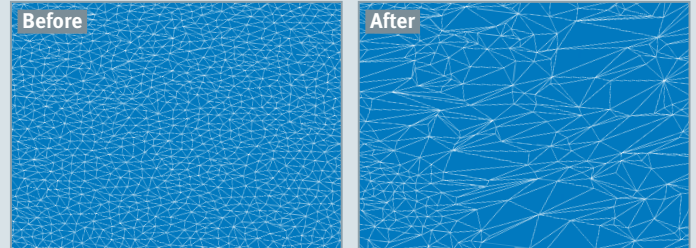

■ Fill mesh areas

This provides a simple and convenient way to close holes in meshes.

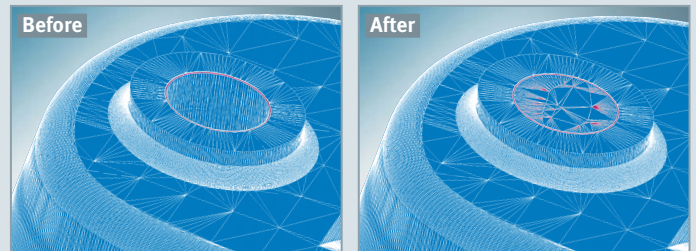

■ Separate mesh clusters

This function allows the user to delete meshes that are not connected.

■ Mesh from faces

A mesh can be generated from faces, open and closed solids.

■ Split meshes

Mesh elements can be split using a planar entity. All the cut triangles are regenerated to ensure that a smooth cut is achieved.

hyperCAD[®]-S deformation – targeted deformation of geometries

The targeted deformation of geometries is an important requirement placed on CAD systems by design and CAM programming. CAM users need to be able to deform geometries so that they can produce variants and complex geometries as quickly as possible. Experienced CAM programmers modify geometries in order, for example, to overbend tools or manufacture precision parts.

In *hyperCAD*[®]-S, the Deformation module is used to deform all geometries in accordance with their requirements. This powerful modification tool allows modifying global and local component areas in a way that would be very costly using traditional modelling techniques.

Go faster to the desired end geometry!

Features

- Schnell Fast and simple
- Deform entities
- Volumetric deformation

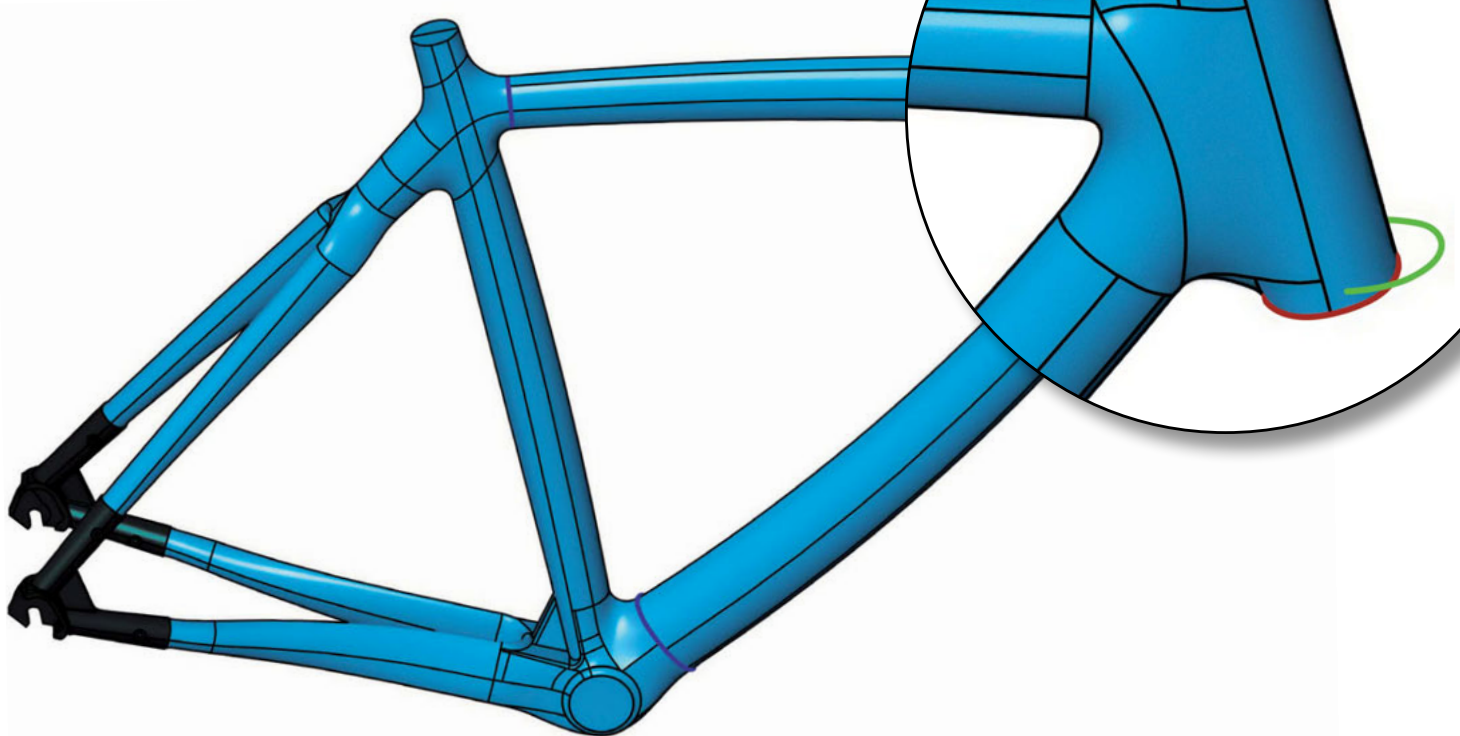

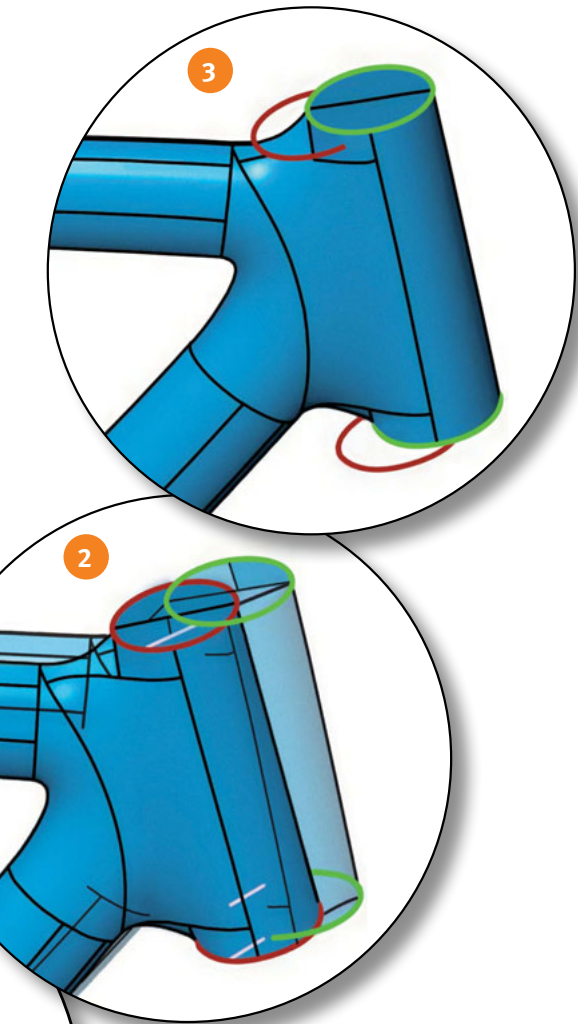

- Volumetric deformation:** Starting from an initial face, selected entities (faces, curves, points, point clouds and meshes) are deformed volumetrically to a target face.

Italian bike
on YouTube



Application areas

- Compensating for manufacturing variations:** Application of manufacturing variations to produce precision parts.

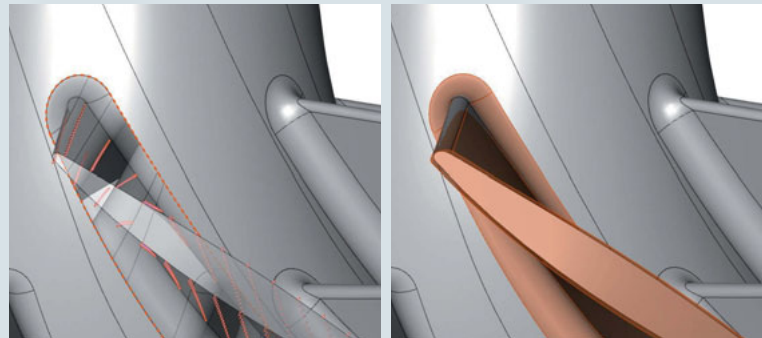
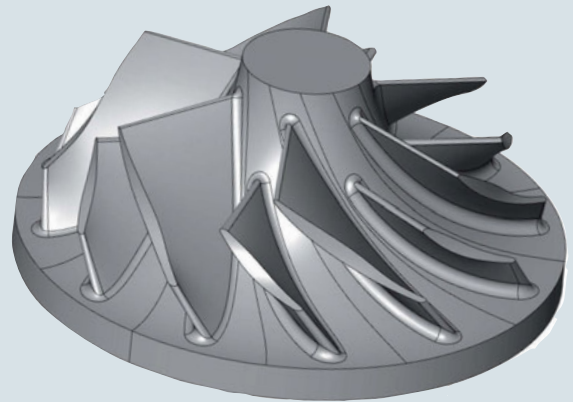

- Creating complex geometries:** Transferring a 2D logo or a tread pattern to a 3D geometry using volumetric deformation.

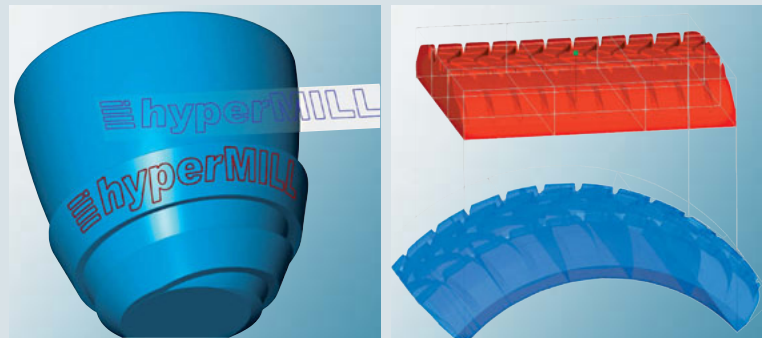

- Deforming entities:** Starting from start contours or points, selected entities such as faces, curves, points, point clouds and meshes (green) are deformed to target contours or points (red). Areas can also be fixed here.

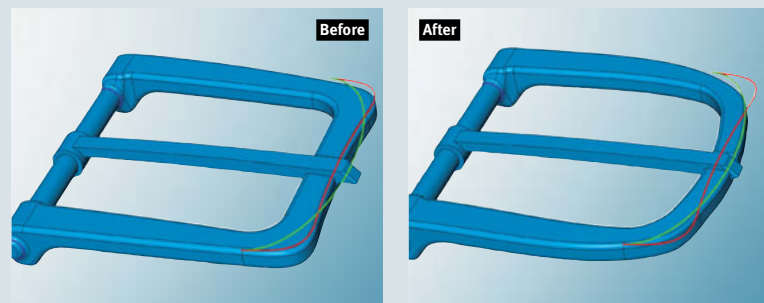

Viewer for CAD and CAM files: more transparency, fewer errors.

hyperCAD[®]-S Viewer is available for *hyperCAD*[®]-S. This makes it possible to view CAD files. *hyperMILL*[®] SHOP Viewer is also available for *hyperCAD*[®]-S. This makes it possible to view CAM data from *hyperMILL*[®]. *hyperCAD*[®]-S Viewer is ideal for departments that simply want to take a brief look at their CAD data, for example, in job planning or quote calculation. *hyperCAD*[®]-S Viewer optionally offers all current direct interfaces and tried-and-tested neutral data formats.

hyperMILL[®] SHOP Viewer not only allows the user to view CAD data; they can also view CAM data from *hyperMILL*[®]. This extends the options that are available to machine operators as, until now, only the NC programs were available to them for set-ups. With *hyperMILL*[®] SHOP Viewer – the visualisation solution for the workshop – data that is relevant to production can be visualised and simulated directly next to the machine. Every manufacturing operation can be checked in detail on the monitor before the set-up. This results in a far better understanding of the actual manufacturing process than before and the machine operator can apply their manufacturing expertise more effectively.



**Simple and fast display,
analysis and documentation of CAM/CAD data.**

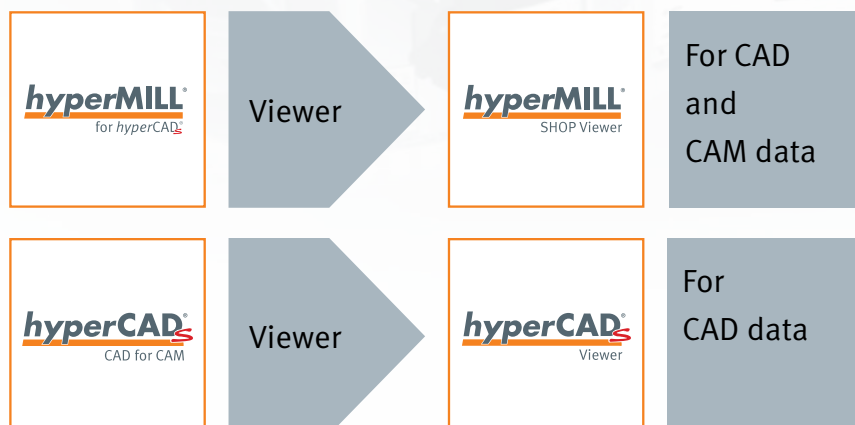



Fast access: *hyperCAD*[®]-S Viewer allows quick access to the geometry and component structure.



Increased process reliability: *hyperMILL*[®] SHOP Viewer allows experienced machine operators to recognise possible errors early on before the start of manufacturing using virtual process analyses.

Features: *hyperCAD*[®]-S Viewer

- **Target groups:** The Viewer is particularly used in departments that simply want to take a brief look at their CAD data, for example, in job planning or quote calculation.
- **CAD interfaces:** The Viewer supports an extensive package of import interfaces: *hyperCAD*[®] files, IGES, STEP, DXF/DWG, point cloud, Parasolid[®] and optional Catia V4[®] and V5[®], Autodesk[®] Inventor[®], Siemens NX[®], SOLIDWORKS, PTC[®] Creo.

Features: *hyperMILL*[®] SHOP Viewer

- **Target group:** Machine operators can better leverage their in-depth manufacturing knowledge with *hyperMILL*[®] SHOP Viewer. Machining processes and parameters can be confirmed on the computer rather than adding risk to the machine tool or machined part.
- **Application area:** *hyperMILL*[®] SHOP Viewer is designed for quick access in the manufacturing environment during the post-CAM programming phase.
- **Simulating manufacturing processes:** The traceability of NC programs is noticeably improved through the toolpath simulation, the material removal simulation and the internal machine simulation. The manufacturing processes with the corresponding clamping status can be safely simulated starting with the stockmodel.
- **Verifying details:** Display of all elements and parameters (geometry, features and toolpaths) as in *hyperMILL*[®]. With a few clicks, the operator can measure and check the toolpaths on the machine, for example.
- **Improved communication:** Detailed information about *hyperMILL*[®] jobs are immediately and consistently available for all parties involved in the manufacturing process.
- **Fast access:** *hyperMILL*[®] SHOP Viewer allows quick access to all manufacturing data, as well as to the geometry and component structure.
- **Practical:** The SHOP Viewer file contains optional configuration files such as the machine model, postprocessor and POF files. This ensures that the project data is easily opened on all *hyperMILL*[®] SHOP Viewer workstations, without the need for any special setup.

Everything from CAD to CAM

Improved workflow is now also possible during CAM programming. OPEN MIND's own CAD core makes CAM transitions ultra fast. *hyperMILL*® is fully integrated in *hyperCAD*®-S – the two cores are effectively joined together. This allows CAM programmers to get the most out of their machines in even less time.

Direct access to all CAD functions has a noticeable effect on the overall performance of the CAD/CAM system. Greater transparency improves user-friendliness And users have immediate access to these functions. All new and existing *hyperMILL*® users will quickly feel at home in the *hyperCAD*®-S environment and come to appreciate the many advantages it has to offer.

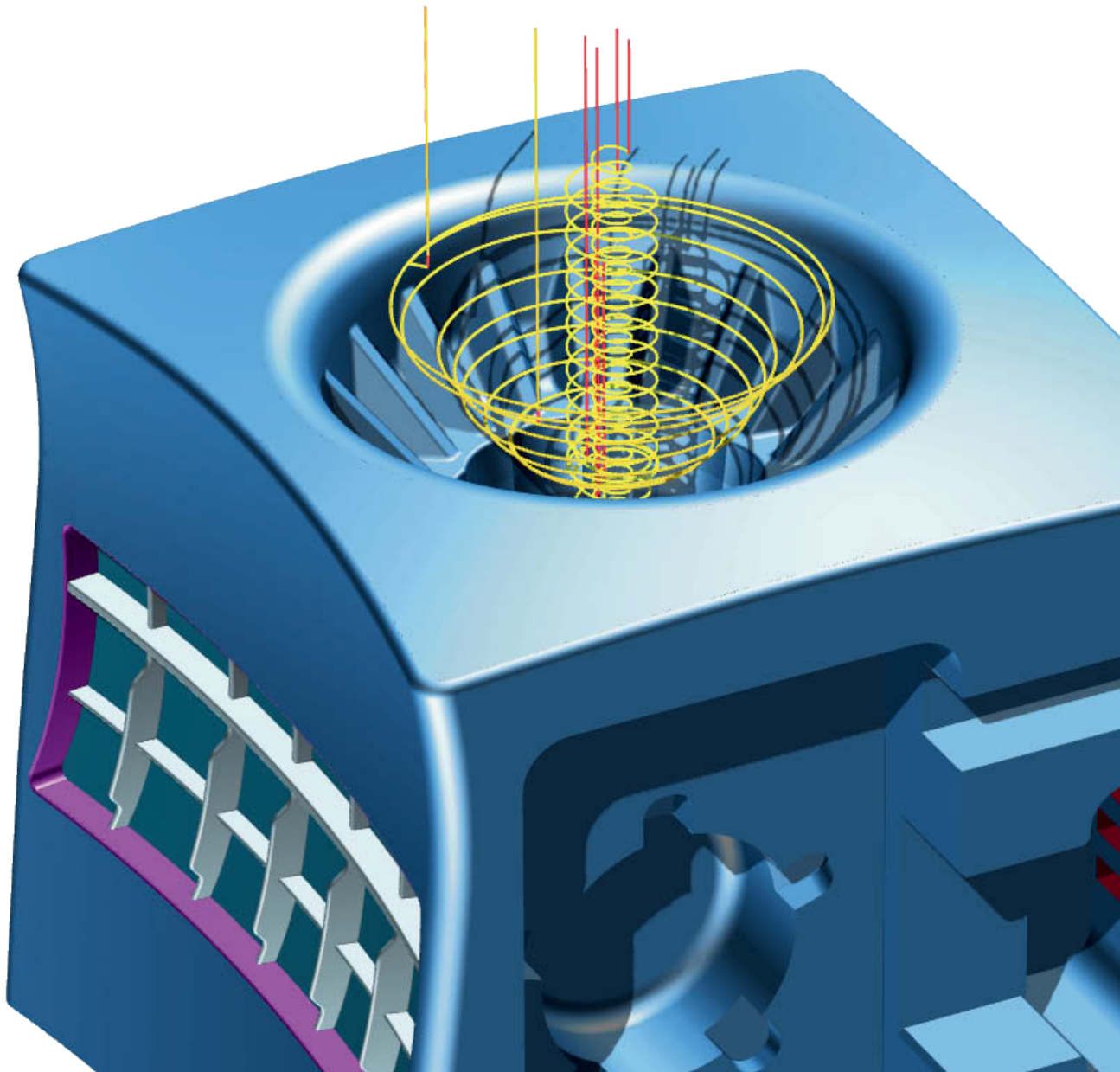



Top machining results with *hyperCAD*[®]-S and *hyperMILL*[®]

- **hyperMILL[®] is fully integrated in hyperCAD[®]-S:** No changes have been made to the tried and tested *hyperMILL*[®] interface concept in *hyperCAD*[®].
- **Intelligent functions:** Stock tracking, job linking, transformation, milling and stop face concepts and automatic collision avoidance provide highly effective techniques.
- **Direct measuring:** Direct measuring on toolpaths and stock models is very useful.
- **Efficient workflows:** Functions such as associative programming, parameter programming and automatic operations via API (Application Programming Interface) vastly reduce the amount of programming effort required.
- **Clearly structured CAM projects:** All CAD and CAM functions are available in a single user interface. Administrative tools, such as job lists or component jobs in the *hyperMILL*[®] browser, enable a highly transparent and reliable workflow.

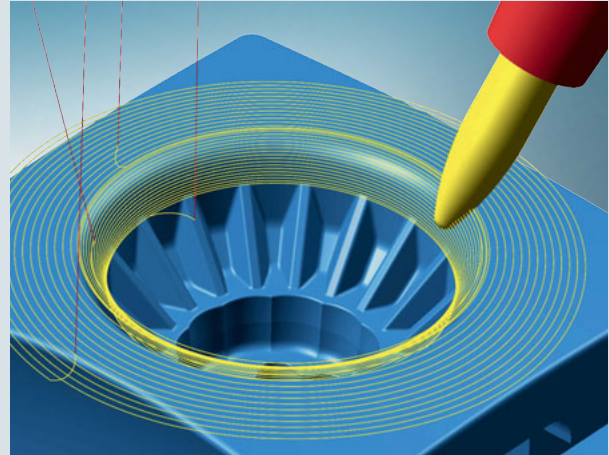
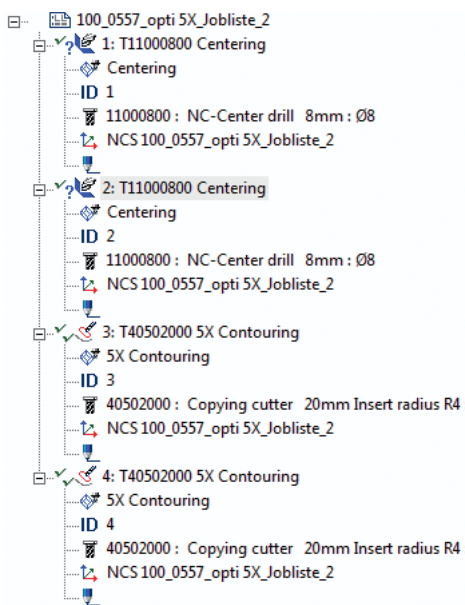

- **Numerous machining strategies:** *hyperMILL*[®] offers solutions for mill turning, as well as 2D, 3D, HSC and 5axis simultaneous and special applications.
- **Cutting-edge CAM technologies:** The standardisation and automation of programming using the latest feature and macro technology and the definition of job templates and operating standards makes everyday work that much easier.
- **Tool selection:** *hyperMILL*[®] provides users with modern, flexible tool database technology that automatically synchronises with other systems. This allows users to create, manage and fully assemble tools with ease.
- **Postprocessors (PPs):** PPs generate programs that are optimally adapted to the respective machines, controllers and components. Note for *hyperCAD*[®] customers: Your PPs are ready for use in *hyperCAD*[®]-S.

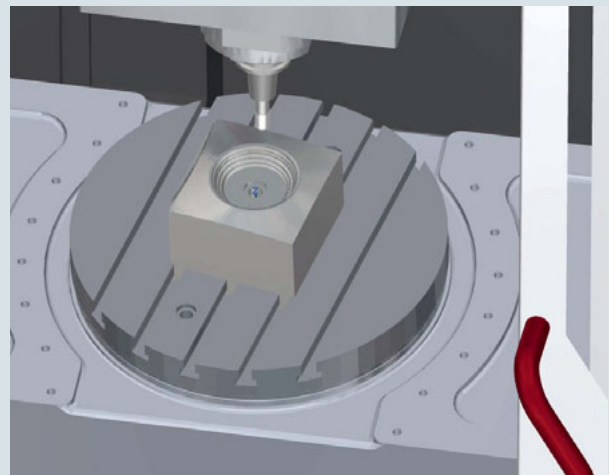

- **Simulation:** *hyperMILL*[®]'s comprehensive machine and material removal simulation makes it possible to reliably monitor the workspace and check for collisions before machining begins.

- Headquarters** OPEN MIND Technologies AG
Argelsrieder Feld 5 • 82234 Wessling • Germany
Phone: +49 8153 933-500
E-mail: Info.Europe@openmind-tech.com
Support.Europe@openmind-tech.com
- UK** OPEN MIND Technologies UK Ltd.
Units 1 and 2 • Bicester Business Park
Telford Road • Bicester • Oxfordshire OX26 4LN • UK
Phone: +44 1869 290003
E-mail: Info.UK@openmind-tech.com
- USA** OPEN MIND Technologies USA, Inc.
1492 Highland Avenue, Unit 3 • Needham MA 02492 • USA
Phone: +1 888 516-1232
E-mail: Info.Americas@openmind-tech.com
- Brazil** OPEN MIND Tecnologia Brasil LTDA
Av. Andromeda, 885 SL2021
06473-000 • Alphaville Empresarial
Barueri • Sao Paulo • Brasil
Phone: +55 11 2424 8580
E-mail: Info.Brazil@openmind-tech.com
- Asia Pacific** OPEN MIND Technologies Asia Pacific Pte. Ltd.
33 Ubi Avenue 3 #06-32 • Vertex (Tower B)
Singapore 408868 • Singapore
Phone: +65 6742 95-56
E-mail: Info.Asia@openmind-tech.com
- China** OPEN MIND Technologies China Co. Ltd.
Suite 1608 • Zhong Rong International Plaza
No. 1088 South Pudong Road
Shanghai 200120 • China
Phone: +86 21 588765-72
E-mail: Info.China@openmind-tech.com
- India** OPEN MIND CAD/CAM Technologies India Pvt. Ltd.
3C-201, 2nd Floor • 2nd Main Road • Kasturi Nagar
Bangalore 560 043 • Karnataka • India
Phone: +91 80 3232 4647
E-mail: Info.India@openmind-tech.com
- Japan** OPEN MIND Technologies Japan K.K.
Misumi Bldg. 3F • 1-17-18, Kichijojihigashicho
Musashino-shi • Tokyo 180-0002 • Japan
Phone: +81 422 23-5305
E-mail: info.jp@openmind-tech.co.jp
- Taiwan** OPEN MIND Technologies Taiwan Inc.
3F., No.153, Huanbei Rd., Zhongli Dist. • Taoyuan City 32055
Taiwan (R.O.C.)
Phone: +886 3 46131-25
E-mail: Info.Taiwan@openmind-tech.com

OPEN MIND Technologies AG is represented worldwide with own subsidiaries and through competent partners and is a member of the Mensch und Maschine technology group, www.mum.de

www.openmind-tech.com



We push machining to the limit